

andrew James

Slow Juicer



Thank you for your purchase. We hope that you are satisfied with your new Andrew James product.

To fully and safely enjoy the benefits of your new product, please read the manual fully before use and keep safe for future reference.

Safety information

When using any electrical appliance, basic safety precautions should always be followed, including the following;

- This appliance is intended for indoor, household use. Unintended use or operation may result in personal injury, damage to property or damage to the appliance that will void the warranty.
- This appliance can be used by children aged from 8 years and above and persons with reduced physical, sensory or mental capabilities or lack of experience and knowledge if they have been given supervision and/or instruction concerning safe use of the appliance and the understanding of hazards. Children shall not play with the appliance. Cleaning and user maintenance shall not be made by children unless they are older than 8 years old and supervised.
- Keep the appliance and its cord out of reach of children less than 8 years old.
- Never handle or operate any appliance with wet or moist hands.
- Do not immerse appliance, cord or plug in water or other liquids. Take care whilst cleaning.
- If the appliance has fallen in water do not reach for it, immediately switch the appliance off at the mains and unplug it.
- Ensure that the cord is not in a position where it can be pulled or tripped over accidentally. Never use the cord to carry or pull the appliance. Do not let the cord hang over the edge of a table or counter.
- Keep the cord away from heated surfaces.
- Do not use the appliance if it has malfunctioned, been dropped or damaged in anyway. If the unit has been damaged take the unit for examination and/or repair by an authorised service agent.
- Do not attempt to open the appliance, repair or modify the appliance, use the appliance for unintended applications or use accessory attachments not recommended by the manufacturer.

Failure to follow these instructions may result in fire, electrical shock, or risk of injury to persons.

- Do not place the appliance near a naked flame, hot gas or electric burners, or any appliances generating heat.
- Always remove the plug safely from the socket after use. Do not pull from the cord.
- Ensure that all packaging is removed before first use.

Appliance specific safety information



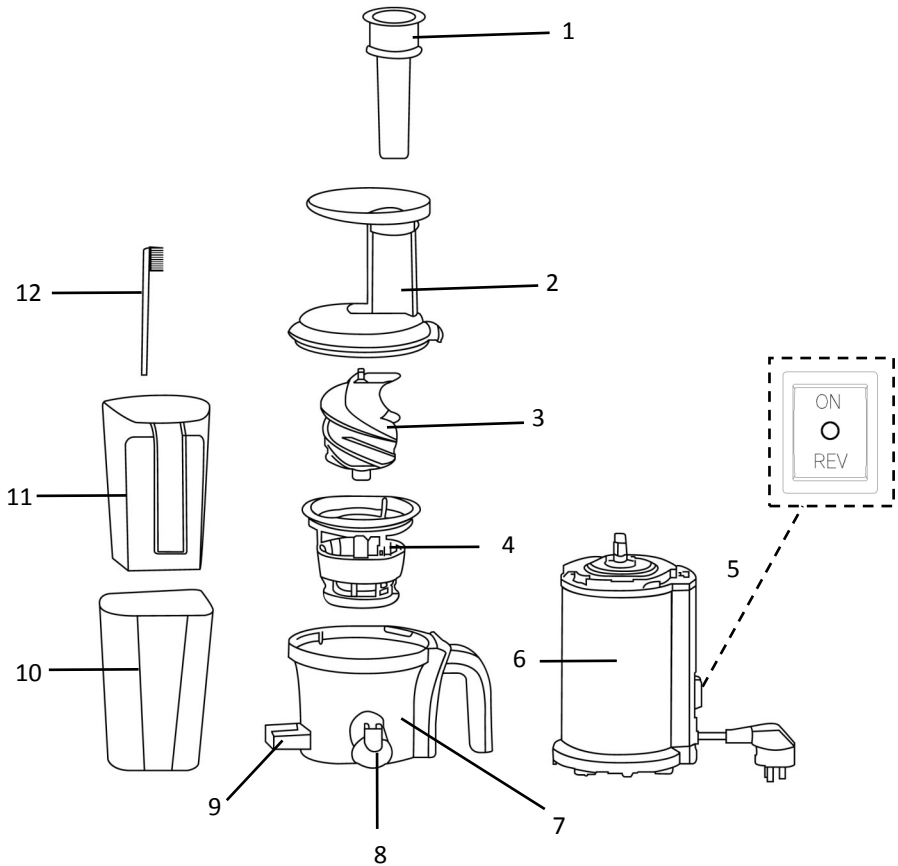

- It is recommended to keep the appliance approximately 30cm away from any other appliances, walls etc during operation to allow sufficient room for ventilation.
- Ensure that the unit is correctly assembled and the safety locks engaged before using.
- Do not operate the slow juicer when it is empty.
- Do not use fingers, utensils or any other foreign objects to push ingredients through the chute. Please only use the food pusher provided.
- This appliance has a rated run time (RRT) of 20 minutes, do not exceed this limit. Always allow a cool down period of at least 15 minutes after use.
- Do not move or touch operating parts when in use to avoid injury to the user.
- All ingredients must be sliced into suitable sizes before being placed into the juicer. For harder fruits and vegetables such as carrots, ensure they are cut into pieces less than 2cm in diameter.
- To avoid damage to the appliance, please ensure that hard cores and pits are removed from fruits such as peaches, cherries, mangos etc before being placed into the juicer.
- The appliance is not suitable for dry foods such as grains.
- The appliance is not suitable for use of frozen fruits or vegetables.

Appliance components

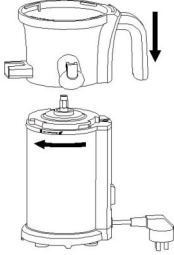

1. Food pusher	5. On/off/reverse switch	9. Pulp outlet
2. Juicing bowl cover with food chute	6. Base unit with plug	10. Pulp pitcher
3. Juice extractor	7. Juicing bowl	11. Juice pitcher with handle
4. Pulp strainer	8. Juice outlet	12. Cleaning brush

Assembling the juicer

	<p>1. Align the “●” mark on the juicing bowl and the “☐” mark on the base unit. Rotate the bowl clockwise until the “●” is aligned with the “☐” to ensure it is locked and secured.</p>
	<p>2. Slot the pulp strainer into the juicing bowl ensuring that it is firmly secured in place.</p>
	<p>3. Place the juice extractor in the centre hole of the juicing bowl and pulp strainer and ensure that it is firmly secured in place.</p>
	<p>4. Align “●” mark on the juicing bowl cover with the “☐” mark on the juicing bowl. Rotate the juicing bowl cover clockwise and ensure “☐” mark is aligned with “●”</p>

Before first use

- Thoroughly clean all parts in contact with food in warm soapy water, rinse and dry thoroughly before using.

Please note: This appliance has a built-in safety lock. This feature ensures that you can only use the appliance if you have assembled the juicer correctly on the base unit. Please ensure all parts are assembled correctly before use.

- Wash fruit and vegetables thoroughly before juicing.
- If juicing fruit with stones or hard seeds, please ensure to pit the fruit before inserting into the appliance. Remove any hard inedible skins such as the skins of melons, pineapples, mangos etc.
- Do not place whole fruit or vegetables into the juicer. We recommend slicing harder fruits and vegetables such as carrots into pieces less than 2cm in diameter.

Using the appliance

How to use:

1. Plug the appliance into the socket and switch on at the mains.
2. Align the juicing pitcher and the pulp pitcher to the correct outlets and ensure the cap on the juicer outlet is open and clear of any debris to avoid any spillage.
3. Insert ingredients into the food chute.
4. Using the **on/off/rev** button, gently switch the appliance to **on**.
5. Gently push the ingredients into the appliance using the food pusher.
6. If the juicing is hindered or begins to clog, gently press and hold the **on/off/rev** button to **rev**. The juice extractor will begin to rotate reversely and will detach and push upwards the trapped pulp. If the reverse function is unable to dislodge the pulp, switch the appliance off at the base unit, then switch off at the mains and unplug the appliance from the socket, allow to fully cool and disassemble the juicer to clean.
7. When the juicing is complete, ensure that the **on/off/rev** control switch is set to the middle **off** position.

Disassembly of the juicer



1. Rotate the juice bowl cover anticlockwise so that the “●” mark is aligned with the “☐” . Pull the juicing bowl gently upwards to remove.



2. Remove the juice extractor from the pulp straining by lifting in an upwards motion.

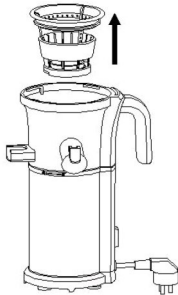

3. Remove the pulp strainer from the juicing bowl.

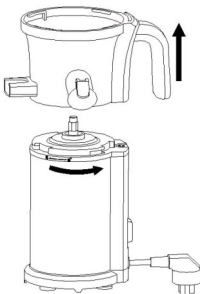

4. Rotate the juicing bowl anticlockwise until the “●” marking aligns with the “☐” marking.

Cleaning and maintenance

- Switch the appliance off at the mains and unplug from the socket.
- Ensure the product is fully cool before disassembling. Carry out disassembly according to ‘disassembly of the juicer’ on the previous page.
- Wash all removeable components in warm soapy water, rinse thoroughly and dry.
- Use the cleaning brush provided to assist with the cleaning of difficult to reach areas.
- **Please note:** This appliance is not dishwasher safe
- Do not wash or immerse the base unit of the slow juicer in water. Wipe the exterior of the base unit with a damp cloth and dry thoroughly.
- Do not use scouring pads or any other abrasive cleaning utensils to clean the appliance and its removeable components.

Troubleshooting

Problem	Solution
Appliance not operating	<ul style="list-style-type: none"> • Check that the power cord and power source are connected and switched on. • Check that all parts have been assembled correctly.
Unable to remove the juicing bowl cover	<ul style="list-style-type: none"> • Check that all residue is removed in the juicing bowl. Set the switch to “rev” to remove any excess debris. • Ensure that the “●” marking is correctly aligned to the “☐”
Appliance stopped working during operation	<ul style="list-style-type: none"> • Check to see if there is too much food inside the juicing bowl. Press “rev” to remove excess food from the juicing bowl. Cut ingredients into smaller pieces and try again.
Bottom of the juicing bowl is leaking	<ul style="list-style-type: none"> • Check that the silicone sealing ring in the centre of the juicing bowl is correctly in place and not damaged. • Ensure that there is not too much food being placed into the juicer and causing the silicon sealing ring to open and leak.

UK and EU warranty

Your new Andrew James product comes with a 24 month guarantee and a 2 year fixed warranty, effective from receipt confirmation. Your receipt or order number is required as proof of purchase date so it is imperative that you keep it safe. This guarantee only applies if the item has been used solely for the use intended, and all instructions have been followed accordingly. Please note this product is only for domestic use only and is not for commercial use.

Abuse of your product will invalidate the guarantee. Returned goods can only be accepted if repackaged properly within the original colour product box, and presented with the original receipt of sale/order number. This does not affect your statutory rights.

Returned products must be cleaned and returned to us in as close to delivery condition as possible.

If your product develops a problem within the first 12 months of the fixed warranty, we will pay all shipping costs to have it returned to us. After 12 months the customer will be liable for the cost of returning the product to us. We will then pay to have the repaired/replaced item shipped back to the customer.

If you wish to return your item for a full refund, you have the right to do so within the first 7 days. For our returns policy please go to:

www.andrewjamesworldwide.com

Customers are responsible for any taxes applied to our products when they are shipped outside of the EU.

All of our prices are inclusive of VAT.

Once a product has been returned to us, we will aim to repair or replace it within 30 days of receipt.

The guarantee does not cover any defect arising from improper use, damage, build-up of lime scale or repair attempts made by third-parties. Also, the guarantee does not cover normal wear and tear of individual parts.

Electrical safety information

Always ensure the voltage on the rating label corresponds to the supply voltage.

WARNING! This appliance must be connected to an earthed electrical power supply. The green/yellow conductor in the supply cord must be connected to the Earth terminal in the plug. The power supply must have an Earth connection.

Check the power cord and plug regularly for any damage. If the cord or the plug is damaged, it must be replaced by a qualified electrician or a service repair centre to avoid a hazard.

Precautions should be followed for safe cable management and connection to the

power supply

If a new mains plug needs to be fitted follow the fitting instructions supplied with good quality BS1363A plugs. If in doubt consult a qualified electrician or appliance repair agent.

- a) Remove and safely dispose of the old plug
- b) Connect the brown lead to the live terminal “L” in the new plug
- c) Connect the Blue lead to the Neutral “N” terminal
- d) Connect the green/yellow lead to the earth “E” terminal
- e) Recommended fuse size 3A

Use of an extension cable is not recommended. If an extension cable is required, it should be rated no less than 13A and be fully unwound before use to avoid overheating. Do not connect multiple appliances to the extension cable

Do not attempt to modify electrical plugs or sockets or attempt to make an alternative connection to the electrical supply.

Disposal of the appliance

Waste Electrical & Electronic Equipment (WEEE) Waste & Recycling Disposal of Electrical and Electronic Waste

Non-household waste. This product must not be disposed of together with ordinary household waste.

Separate collection of used products, batteries and packaging allows the recovery and recycling of materials. Reuse of materials helps prevent environmental pollution and reduces the demand for raw materials.

Local authorities, retailers and collection organisations may provide for separate collection of electrical products, batteries and packaging.



Contact Details

Address: Andrew James UK Ltd, Lighthouse View, Spectrum Business Park, Seaham, Durham, SR7 7PR, UK

Customer Service Telephone: 0191 377 8358

Email: customerservices@andrewjamesworldwide.com

Twitter: @andrewjamesLtd

Facebook: Andrew James

Copyright Andrew James

AJ001545 | 08/2018

www.andrewjamesworldwide.com